

# Flat Backs No Hotfix

Flat Backs No Hotfix are loose crystals backed with platinum foiling for extra brilliance, and protection. Available in a multitude of sizes, colors, shapes and cuts, they are easy to apply to a variety of carrier materials using standard one or two component glues.

The most coveted and famous item in this product group is article 2088 XIRIUS Rose. Incredibly progressive, and completely unique, multi-layer cutting technology is used to create the inspiring XIRIUS star design allowing for superior shine and rich, well-balanced light refraction redefining the market standard.

A reflection of Swarovski's innovation expertise is the 1098 Xirius Light, a groundbreaking hybrid that fuses our most exceptional Swarovski cuts. Combining the height and weight of a Flat Back with additional 8 facets on its backside, it possesses the vigor of a Chaton while maintaining the convenient application of a Flat Back.

Swarovski's outstanding quality is underlined by the highest precision in table size, and diameter.





## Colors & Effects

OPEN TO SEE COLORS & EFFECTS



## Colors







 Crystal 001	 Burgundy 515	 Blue Zircon 229
 White Opal 234	 Amethyst 204	 Erinite 360
 Light Silk 261	 Iris 219	 Chrysolite 238
 Silk 391	 Light Amethyst 212	 Peridot 214
 Light Peach 362	 Provence Lavender 283	 Citrus Green 337
 Vintage Rose 319	 Tanzanite 539	 Fern Green 291
 Blush Rose 257	 Purple Velvet 277	 Emerald 205
 Light Rose 223	 Aquamarine 202	 Jonquil 213
 Rose Peach 262	 Light Sapphire 211	 Light Topaz 226
 Padparadscha 542	 Sapphire 206	 Golden Topaz 1003
 Indian Pink 289	 Capri Blue 243	 Light Colorado Topaz 246
 Rose 209	 Majestic Blue 296	 Topaz 203
 Fuchsia 502	 Cobalt 369	 Light Amber 1002
 Light Siam 227	 Dark Indigo 288	 Smoked Amber 1001
 Scarlet 276	 Montana 207	 Greige 284
 Indian Siam 327	 Denim Blue 266	 Black Diamond 215
 Siam 208	 Indicolite 379	 Graphite 253
 Ruby 501	 Light Turquoise 263	 Jet 280

## Effects







-  Crystal Moonlight  
001 MOL
-  Crystal Shimmer  
001 SHIM
-  Crystal Aurore Boreale  
001 AB
-  Crystal Paradise Shine  
001 PARSH
-  Crystal Volcano  
001 VOL
-  Crystal Blue Shade  
001 BLSH
-  Crystal Golden Shadow  
001 GSHA
-  Crystal Metallic Sunshine  
001 METSH
-  Crystal Rose Gold  
001 ROGL
-  Crystal Light Chrome  
001 LTCH
-  Crystal Silver Shade  
001 SSHA
-  Crystal Silver Night  
001 SINI
-  Jet Hematite  
280 HEM

## Crystal Lacquer<sup>PRO</sup> Effects

### Crystal Lacquer<sup>PRO</sup> Ignite Effects

-  Crystal Linen Ignite  
001 L164I
-  Crystal Flamingo Ignite  
001 L162I
-  Crystal Orange Ignite  
001 L159I
-  Crystal Maroon Ignite  
001 L160I
-  Crystal Purple Ignite  
001 L161I
-  Crystal Sky Ignite  
001 L163I





### Crystal Electric Lacquer<sup>PRO</sup> Effects

-  Crystal Electric White  
001 L139S
-  Crystal Electric Orange  
001 L136S
-  Crystal Electric Pink  
001 L137S
-  Crystal Electric Violet  
001 L148S
-  Crystal Electric Blue  
001 L134S
-  Crystal Electric Green  
001 L135S
-  Crystal Electric Yellow  
001 L138S

## Shimmer Effects

-  Silk Shimmer  
391 SHIM
-  Light Rose Shimmer  
223 SHIM
-  Fuchsia Shimmer  
502 SHIM
-  Light Siam Shimmer  
227 SHIM
-  Tanzanite Shimmer  
539 SHIM
-  Light Sapphire Shimmer  
211 SHIM
-  Blue Zircon Shimmer  
229 SHIM
-  Peridot Shimmer  
214 SHIM
-  Topaz Shimmer  
203 SHIM
-  Black Diamond Shimmer  
215 SHIM

## AB Effects

-  Light Rose Aurore Boreale  
223 AB
-  Light Siam Aurore Boreale  
227 AB
-  Sapphire Aurore Boreale  
206 AB
-  Jonquil Aurore Boreale  
213 AB

## Nightfall Effects

-  Siam Nightfall  
208 NIFA
-  Capri Blue Nightfall  
243 NIFA
-  Emerald Nightfall  
205 NIFA
-  Graphite Nightfall  
253 NIFA



## Numerical Order

001	Crystal	206	Sapphire	262	Rose Peach
001 AB	Crystal Aurore Boreale	207	Montana	263	Light Turquoise
001 BLSH	Crystal Blue Shade	208 NIFA	Siam Nightfall	266	Denim Blue
001 GSHA	Crystal Golden Shadow	208	Siam	276	Scarlet
001 LI34S	Crystal Electric Blue	209	Rose	277	Purple Velvet
001 LI35S	Crystal Electric Green	211 SHIM	Light Sapphire Shimmer	280 HEM	Jet Hematite
001 LI36S	Crystal Electric Orange	211	Light Sapphire	280	Jet
001 LI37S	Crystal Electric Pink	212	Light Amethyst	283	Provence Lavender
001 LI38S	Crystal Electric Yellow	213 AB	Jonquil Aurore Boreale	284	Greige
001 LI39S	Crystal Electric White	213	Jonquil	288	Dark Indigo
001 LI48S	Crystal Electric Violet	214 SHIM	Peridot Shimmer	289	Indian Pink
001 LI59I	Crystal Orange Ignite	214	Peridot	291	Fern Green
001 LI60I	Crystal Maroon Ignite	215 SHIM	Black Diamond Shimmer	296	Majestic Blue
001 LI61I	Crystal Purple Ignite	215	Black Diamond	319	Vintage Rose
001 LI62I	Crystal Flamingo Ignite	219	Iris	327	Indian Siam2
001 LI63I	Crystal Sky Ignite	223 AB	Light Rose Aurore Boreale	337	Citrus Green
001 LI64I	Crystal Linen Ignite	223 SHIM	Light Rose Shimmer	360	Erinite
001 LTCH	Crystal Light Chrome	223	Light Rose	362	Light Peach
001 METSH	Crystal Metallic Sunshine	226	Light Topaz	369	Cobalt
001 MOL	Crystal Moonlight	227 AB	Light Siam Aurore Boreale	379	Indicolite
001 PARSH	Crystal Paradise Shine	227 SHIM	Light Siam Shimmer	391 SHIM	Silk Shimmer
001 ROGL	Crystal Rose Gold	227	Light Siam	391	Silk
001 SHIM	Crystal Shimmer	229 SHIM	Blue Zircon Shimmer	501	Ruby
001 SINI	Crystal Silver Night	229	Blue Zircon	502 SHIM	Fuchsia Shimmer
001 SSHA	Crystal Silver Shade	234	White Opal	502	Fuchsia
001 VOL	Crystal Volcano	238	Chrysolite	515	Burgundy
202	Aquamarine	243 NIFA	Capri Blue Nightfall	539 SHIM	Tanzanite Shimmer
203 SHIM	Topaz Shimmer	243	Capri Blue	539	Tanzanite
203	Topaz	246	Light Colorado Topaz	542	Padparadscha
204	Amethyst	253 NIFA	Graphite Nightfall	1001	Smoked Amber
205 NIFA	Emerald Nightfall	253	Graphite	1002	Light Amber
205	Emerald	257	Blush Rose	1003	Golden Topaz
206 AB	Sapphire Aurore Boreale	261	Light Silk		

## Alphabetical Order

Amethyst (204)	Crystal Rose Gold (001 ROGL)	Light Sapphire (211)
Aquamarine (202)	Crystal Shimmer (001 SHIM)	Light Sapphire Shimmer (211 SHIM)
Black Diamond (215)	Crystal Silver Night (001 SINI)	Light Siam (227)
Black Diamond Shimmer (215 SHIM)	Crystal Silver Shade (001 SSHA)	Light Siam Aurore Boreale (227 AB)
Blue Zircon (229)	Crystal Sky Ignite (001 LI63I)	Light Siam Shimmer (227 SHIM)
Blue Zircon Shimmer (229 SHIM)	Crystal Volcano (001 VOL)	Light Silk (261)
Blush Rose (257)	Dark Indigo (288)	Light Topaz (226)
Burgundy (515)	Denim Blue (266)	Light Turquoise (263)
Capri Blue (243)	Emerald (205)	Majestic Blue (296)
Capri Blue Nightfall (243 NIFA)	Emerald Nightfall (205 NIFA)	Montana (207)
Chrysolite (238)	Erinite (360)	Padparadscha (542)
Citrus Green (337)	Fern Green (291)	Peridot (214)
Cobalt (369)	Fuchsia (502)	Peridot Shimmer (214 SHIM)
Crystal (001)	Fuchsia Shimmer (502 SHIM)	Provence Lavender (283)
Crystal Aurore Boreale (001 AB)	Golden Topaz (1003)	Purple Velvet (277)
Crystal Blue Shade (001 BLSH)	Graphite (253)	Rose (209)
Crystal Electric Blue (001 LI34S)	Graphite Nightfall (253 NIFA)	Rose Peach (262)
Crystal Electric Green (001 LI35S)	Greige (284)	Ruby (501)
Crystal Electric Orange (001 LI36S)	Indian Pink (289)	Sapphire (206)
Crystal Electric Pink (001 LI37S)	Indian Siam2 (327)	Sapphire Aurore Boreale (206 AB)
Crystal Electric Violet (001 LI48S)	Indicolite (379)	Scarlet (276)
Crystal Electric White (001 LI39S)	Iris (219)	Siam (208)
Crystal Electric Yellow (001 LI38S)	Jet Hematite (280 HEM)	Siam Nightfall (208 NIFA)
Crystal Flamingo Ignite (001 LI62I)	Jet (280)	Silk (391)
Crystal Golden Shadow (001 GSXA)	Jonquil (213)	Silk Shimmer (391 SHIM)
Crystal Light Chrome (001 LTCH)	Jonquil Aurore Boreale (213 AB)	Smoked Amber (1001)
Crystal Linen Ignite (001 LI64I)	Light Amber (1002)	Tanzanite (539)
Crystal Maroon Ignite (001 LI60I)	Light Amethyst (212)	Tanzanite Shimmer (539 SHIM)
Crystal Metallic Sunshine (001 METSH)	Light Colorado Topaz (246)	Topaz (203)
Crystal Moonlight (001 MOL)	Light Peach (362)	Topaz Shimmer (203 SHIM)
Crystal Orange Ignite (001 LI59I)	Light Rose (223)	Vintage Rose (319)
Crystal Paradise Shine (001 PARSH)	Light Rose Aurore Boreale (223 AB)	White Opal (234)
Crystal Purple Ignite (001 LI61I)	Light Rose Shimmer (223 SHIM)	

02

For details on available colors and effects for each article within the product groups, please see the product matrix of the respective item in the Collection 2023.

The plating resistance of effects is tested according to Swarovski's plating guidelines (SWAROVSKI.COM/S-PROFESSIONALS). Customers are advised to carry out their own tests if their plating parameters diverge from Swarovski plating guidelines.

Colors and effects can appear different when illuminated with different light sources. Swarovski uses standard light source D65 for color decision and comparison. Slight changes in shades are unavoidable. Colors may vary according to cut and foiling.

The composition of Advanced Crystal is compliant with regulatory industry norms and laws regarding the restriction or prohibition of certain substances in the most relevant segments of our customers. Please note that the compliance of the colors Light Siam and Siam varies according to certain industry regulations. Those regulations are indicated with \* in the compliance overview. Indian Siam, Ruby and Scarlet (option to Lt. Siam) conform to all CLEAR-lists. For further information please visit [swarovski.com/s-professionals](https://www.swarovski.com/s-professionals)

© 2023 D. Swarovski Distribution GmbH

# Summary

1 2 3		<b>1098</b> PP 24 (SS 12), PP 31 (SS 16) SS 20, 24, 29, 34, 39	1 2		<b>2304</b> 6x1.7, 10x2.8, 14x3.9 mm	1 2		<b>2711</b> 3.3 mm
		<b>2000</b> SS 3, 4			<b>2400</b> 2.2, 3, 4, 6 mm			<b>2715</b> 3, 4 mm
		<b>2019</b> 4x4, 5x5, 6x6 mm			<b>2471</b> 5, 7, 10 mm			<b>2716</b> 5 mm
		<b>2035</b> 6, 10, 14, 20, 30, 40 mm			<b>2472</b> 5, 7, 10 mm			<b>2738</b> 10x5, 12x6 mm
		<b>2058</b> SS 5, 6, 7, 8, 9, 10			<b>2483</b> 10, 25 mm			<b>2739</b> 5.8x5.3, 7x6.5 mm
		<b>2072</b> 8, 10, 12 mm			<b>2493</b> 8, 10, 20 mm			<b>2740</b> 8.3x8.3, 10x10 mm
		<b>2088</b> SS 12, 14, 16, 20, 24, 30, 34, 40, 48			<b>2510</b> 3.7x1.9 mm			<b>2754</b> 4, 6 mm
		<b>2200</b> 4x2, 8x4 mm			<b>2520</b> 8x6, 10x8, 14x10 mm			<b>2770</b> 6x3.5, 12x7 mm
		<b>2201</b> 4x1.8, 8x3.5, 14x6 mm			<b>2555</b> 8x2.6, 12x4			<b>2771</b> 6.4x4.2, 8.6x5.6, 12.9x8.3 mm
		<b>2205</b> 7.5, 10, 14 mm			<b>2602</b> 3.7x2.5, 8x5.5, 14x10 mm			<b>2772</b> 6.5x2.1, 8.6x2.8, 12.9x4.2 mm
		<b>2300</b> 8x4.8, 10x6 mm			<b>2603</b> 4x3, 8x6, 14x10 mm			<b>2773</b> 5x3, 6.6x3.9, 9.9x5.9 mm
		<b>2303</b> 8x5, 14x9 mm			<b>2709</b> 10x6, 13x8 mm			<b>2774</b> 6.3x4.2, 8.3x5.6, 12.5x8.4 mm

1 Top view 2 Side view 3 Back view

1 2



**2775**  
5x4.2, 6.7x5.6,  
10x8.4 mm



**2776**  
8.2x4.2, 11x5.6,  
16.5x8.4 mm



**2777**  
5x4.2, 6.7x5.6,  
10x8.4 mm



**2808**  
3.6, 6, 10, 14 mm



**2813**  
8x5.5 mm



**2816**  
5 mm



**2854**  
8, 12 mm



**2856**  
10x7.5, 14x10.5, 18x14 mm

02

**1098 XIRIUS Light**

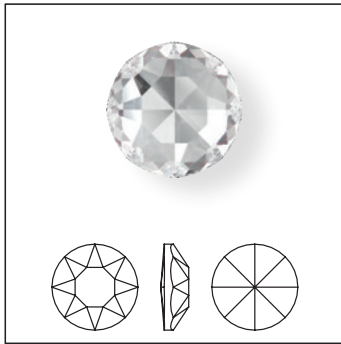

Size	PP 24   SS 12	PP 31   SS 16	SS 20	SS 24	SS 29	SS 34	SS 39
------	---------------	---------------	-------	-------	-------	-------	-------

**Crystal**

Crystal F (001)

**Crystal Effects**

**Transparent Effects**

Crystal Aurore Boreale F (001 AB)

Crystal Golden Shadow F (001 GSHA)

Crystal Silver Night F (001 SINI)

Crystal Silver Shade F (001 SSHA)

Crystal F (001)	■	■	■	■	■	■	■
Crystal Aurore Boreale F (001 AB)	■	■	■	■	■	■	■
Crystal Golden Shadow F (001 GSHA)	■	■	■	■	■	■	■
Crystal Silver Night F (001 SINI)	■	■	■	■	■	■	■
Crystal Silver Shade F (001 SSHA)	■	■	■	■	■	■	■

**2000 Rose**

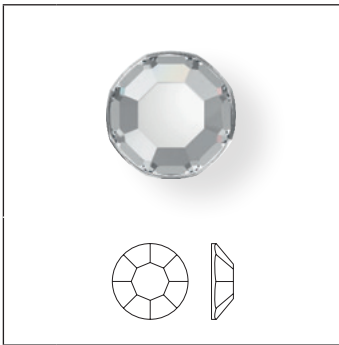

**Size** SS 3, 4

**2058 XILION Rose**

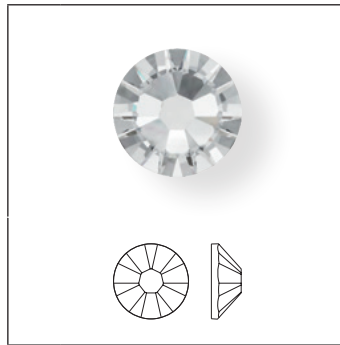

**Size** SS 5, 6, 7, 8, 9, 10

**2088 XIRIUS Rose**

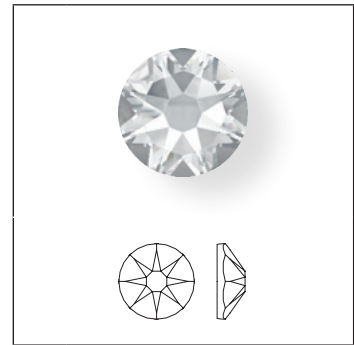

**Size** SS 12, 14, 16, 20, 24, 30, 34, 40, 48

	2000 Rose		2058 XILION Rose							2088 XIRIUS Rose							
	SS 3	SS 4	SS 5	SS 6	SS 7	SS 8	SS 9	SS 10	SS 12	SS 14	SS 16	SS 20	SS 24	SS 30	SS 34	SS 40	SS 48
<b>Crystal</b>																	
Crystal F (001)	■	■	■	■	■	■	■	■	■	■	■	■	■	■	■	■	■
<b>Colors</b>																	
<b>Plain Colors</b>																	
Amethyst F (204)			■	■	■	■	■	■	■	■	■	■	■	■	■	■	■
Aquamarine F (202)	■		■	■	■	■	■	■	■	■	■	■	■	■	■	■	■
Black Diamond F (215)	■		■	■	■	■	■	■	■	■	■	■	■	■	■	■	■
Blue Zircon F (229)			■	■	■	■	■	■	■	■	■	■	■	■	■	■	■
Blush Rose F (257)			■	■	■	■	■	■	■	■	■	■	■	■	■	■	■
Burgundy F (515)			■	■	■	■	■	■	■	■	■	■	■	■	■	■	■
Capri Blue F (243)			■	■	■	■	■	■	■	■	■	■	■	■	■	■	■
Chrysolite F (238)			■	■	■	■	■	■	■	■	■	■	■	■	■	■	■
Citrus Green F (337)			■	■	■	■	■	■	■	■	■	■	■	■	■	■	■
Cobalt F (369)			■	■	■	■	■	■	■	■	■	■	■	■	■	■	■
Dark Indigo F (288)			■	■	■	■	■	■	■	■	■	■	■	■	■	■	■
Denim Blue F (266)			■	■	■	■	■	■	■	■	■	■	■	■	■	■	■
Emerald F (205)			■	■	■	■	■	■	■	■	■	■	■	■	■	■	■
Erinite F (360)			■	■	■	■	■	■	■	■	■	■	■	■	■	■	■

\* All colors with a 4-digit color code (i.e. Golden Topaz) are fully customizable with shorter lead times and lower MOQs compared to our 3-digit colors. Please get in touch with the Customer Service for a time and quantity estimation of your desired variant.

	2000		2058		2088																	
	Size	2000 Rose	SS 3	SS 4	2058 XILLION Rose	SS 5	SS 6	SS 7	SS 8	SS 9	SS 10	2088 XIRIUS Rose	SS 12	SS 14	SS 16	SS 20	SS 24	SS 30	SS 34	SS 40	SS 48	
Fern Green F (291)						■		■		■			■		■		■		■		■	
Fuchsia F (502)						■		■		■			■		■		■		■		■	
Golden Topaz F (1003)*			■			■		■		■			■		■		■		■		■	
Graphite F (253)						■		■		■			■		■		■		■		■	
Greige F (284)						■		■		■			■		■		■		■		■	
Indian Pink F (289)						■		■		■			■		■		■		■		■	
Indian Siam F (327)			■			■		■		■			■		■		■		■		■	
Indicolite F (379)						■		■		■			■		■		■		■		■	
Iris F (219)						■		■		■			■		■		■		■		■	
Jet (280)			■			■		■		■			■		■		■		■		■	
Jet F (280)			■			■	■	■	■	■	■		■		■		■		■		■	
Jonquil F (213)						■		■		■			■		■		■		■		■	
Light Amber F (1002)*			■			■		■		■			■		■		■		■		■	
Light Amethyst F (212)						■		■		■			■		■		■		■		■	
Light Colorado Topaz F (246)			■			■		■		■			■		■		■		■		■	
Light Peach F (362)						■		■		■			■		■		■		■		■	
Light Rose F (223)			■			■		■		■			■		■		■		■		■	
Light Sapphire F (211)						■		■		■			■		■		■		■		■	
Light Siam F (227)						■		■		■			■		■		■		■		■	
Light Silk F (261)						■		■		■			■		■		■		■		■	
Light Topaz F (226)						■		■		■			■		■		■		■		■	
Light Turquoise F (263)						■		■		■			■		■		■		■		■	
Majestic Blue F (296)						■		■		■			■		■		■		■		■	
Montana F (207)						■		■		■			■		■		■		■		■	
Padparadscha F (542)						■		■		■			■		■		■		■		■	
Peridot F (214)						■		■		■			■		■		■		■		■	
Provence Lavender F (283)						■		■		■			■		■		■		■		■	
Purple Velvet F (277)						■		■		■			■		■		■		■		■	
Rose F (209)			■			■		■		■			■		■		■		■		■	
Rose Peach F (262)						■		■		■			■		■		■		■		■	
Ruby F (501)						■		■		■			■		■		■		■		■	
Sapphire F (206)						■		■		■			■		■		■		■		■	

\* All colors with a 4-digit color code (i.e. Golden Topaz) are fully customizable with shorter lead times and lower MOQs compared to our 3-digit colors. Please get in touch with the Customer Service for a time and quantity estimation of your desired variant.

	2000		2058							2088												
	Size	2000 Rose	SS 3	SS 4	2058 XILLION Rose	SS 5	SS 6	SS 7	SS 8	SS 9	SS 10	2088 XIRIUS Rose	SS 12	SS 14	SS 16	SS 20	SS 24	SS 30	SS 34	SS 40	SS 48	
Scarlet F (276)						■		■		■			■		■		■		■		■	
Siam F (208)						■		■		■			■		■		■		■		■	
Silk F (391)						■		■		■			■		■		■		■		■	
Smoked Amber F (1001)*		■				■		■		■			■		■		■		■		■	
Tanzanite F (539)						■		■		■			■		■		■		■		■	
Topaz F (203)						■		■		■			■		■		■		■		■	
Vintage Rose F (319)						■		■		■			■		■		■		■		■	
<b>Opal Colors</b>																						
White Opal F (234)						■		■		■			■		■		■		■		■	
<b>Crystal Effects</b>																						
<b>Transparent Effects</b>																						
Crystal Aurore Boreale F (001 AB)		■	■			■	■	■	■	■	■		■	■	■	■	■	■	■	■	■	■
Crystal Blue Shade F (001 BLSH)						■		■		■			■		■		■		■		■	
Crystal Golden Shadow F (001 GSHA)		■				■		■		■			■		■		■		■		■	
Crystal Moonlight F (001 MOL)						■		■		■			■		■		■		■		■	
Crystal Paradise Shine F (001 PARSH)						■		■		■			■		■		■		■		■	
Crystal Shimmer F (001 SHIM)						■		■		■			■		■		■		■		■	
Crystal Silver Night F (001 SINI)		■				■		■		■			■		■		■		■		■	
Crystal Silver Shade F (001 SSHA)		■				■		■		■			■		■		■		■		■	
Crystal Volcano F (001 VOL)						■		■		■			■		■		■		■		■	
<b>Metallic Effects</b>																						
Crystal Light Chrome F (001 LTCH)						■		■		■			■		■		■		■		■	
Crystal Metallic Sunshine F (001 METSH)						■		■		■			■		■		■		■		■	
Crystal Rose Gold F (001 ROGL)		■				■		■		■			■		■		■		■		■	
<b>Crystal Lacquer<sup>PRO</sup> Effects</b>																						
<b>Crystal Lacquer<sup>PRO</sup> Ignite Effects</b>																						
Crystal Flamingo Ignite (001 L162I)													■		■		■		■		■	
Crystal Linen Ignite (001 L164I)													■		■		■		■		■	
Crystal Maroon Ignite (001 L160I)													■		■		■		■		■	
Crystal Orange Ignite (001 L159I)													■		■		■		■		■	
Crystal Purple Ignite (001 L161I)													■		■		■		■		■	
Crystal Sky Ignite (001 L163I)													■		■		■		■		■	



2000 2058 2088		Size	2000 Rose	SS 3	SS 4	2058 XILLION Rose	SS 5	SS 6	SS 7	SS 8	SS 9	SS 10	2088 XIRIUS Rose	SS 12	SS 14	SS 16	SS 20	SS 24	SS 30	SS 34	SS 40	SS 48	
<b>Crystal Electric Lacquer<sup>PRO</sup> Effects</b>																							
	Crystal Electric Blue (001 L134S)													■		■	■		■				
	Crystal Electric Green (001 L135S)													■		■	■		■				
	Crystal Electric Orange (001 L136S)													■		■	■		■				
	Crystal Electric Pink (001 L137S)													■		■	■		■				
	Crystal Electric Violet (001 L148S)													■		■	■		■				
	Crystal Electric White (001 L139S)													■		■	■		■				
	Crystal Electric Yellow (001 L138S)													■		■	■		■				
<b>Color Effects</b>																							
<b>Transparent Effects</b>																							
	Black Diamond Shimmer F (215 SHIM)						■				■			■		■	■		■				
	Blue Zircon Shimmer F (229 SHIM)						■				■			■		■	■		■				
	Capri Blue Nightfall F (243 NIFA)						■				■			■		■	■		■		■		
	Emerald Nightfall F (205 NIFA)						■				■			■		■	■		■		■		
	Fuchsia Shimmer F (502 SHIM)						■				■			■		■	■		■				
	Graphite Nightfall F (253 NIFA)						■				■			■		■	■		■		■		
	Jonquil AB F (213 AB)						■				■			■		■	■		■				
	Light Rose AB F (223 AB)						■				■			■		■	■		■				
	Light Rose Shimmer F (223 SHIM)						■				■			■		■	■		■				
	Light Sapphire Shimmer F (211 SHIM)						■				■			■		■	■		■				
	Light Siam AB F (227 AB)						■				■			■		■	■		■				
	Light Siam Shimmer F (227 SHIM)						■				■			■		■	■		■				
	Peridot Shimmer F (214 SHIM)						■				■			■		■	■		■				
	Sapphire AB F (206 AB)						■				■			■		■	■		■				
	Siam Nightfall F (208 NIFA)						■				■			■		■	■		■		■		
	Silk Shimmer F (391 SHIM)						■				■			■		■	■		■				
	Tanzanite Shimmer F (539 SHIM)						■				■			■		■	■		■				
	Topaz Shimmer F (203 SHIM)						■				■			■		■	■		■				
<b>Metallic Effects</b>																							
	Jet Hematite F (280 HEM)			■			■		■		■			■		■	■		■		■		

2019 Round Spike Flat Back

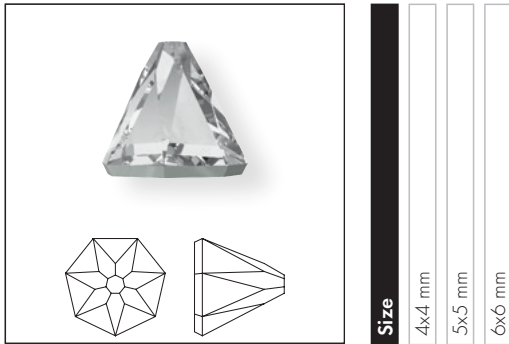

Size  
4x4 mm  
5x5 mm  
6x6 mm

Crystal

Crystal F (001)

Crystal Effects

Transparent Effects

Crystal Aurore Boreale F (001 AB)

Crystal Blue Shade F (001 BLSH)

Crystal Golden Shadow F (001 GSHA)

Crystal Volcano F (001 VOL)

Color Effects

Transparent Effects

Black Diamond Shimmer F (215 SHIM)

Light Topaz Shimmer F (226 SHIM)

2035 Chessboard Circle Flat Back

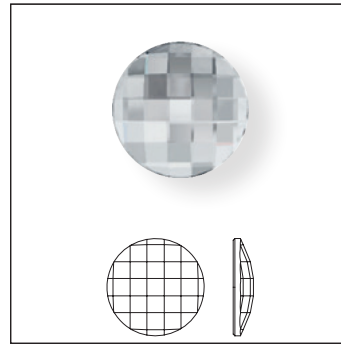

Size  
6 mm  
10 mm  
14 mm  
20 mm  
30 mm  
40 mm

Crystal

Crystal F (001)

Crystal Effects

Metallic Effects

Crystal Comet Argent Light V SI (001 CAVSI)

02

2072 Rose Cut Flat Back

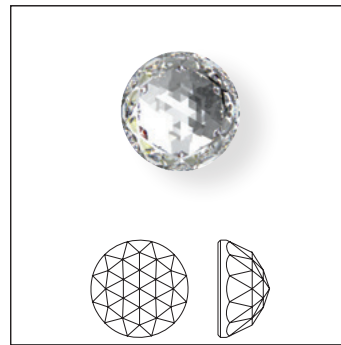

Size  
8 mm  
10 mm  
12 mm

Crystal

Crystal F (001)

**2200 Navette Flat Back**

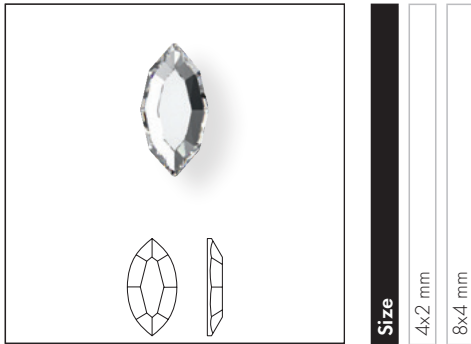

**Size**  
4x2 mm  
8x4 mm

**Crystal**

Crystal F (001)

**Colors**

**Plain Colors**

Scarlet F (276)

**Crystal Effects**

**Transparent Effects**

Crystal Aurore Boreale F (001 AB)

Crystal Golden Shadow F (001 GSHA)

**2201 Marquise Flat Back**

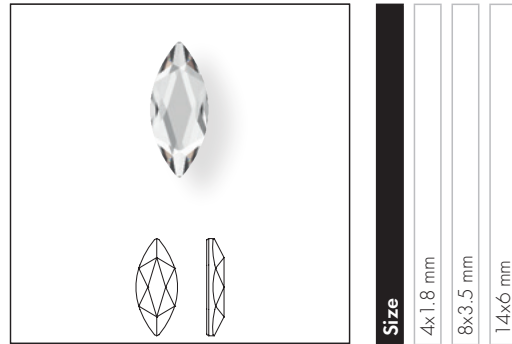

**Size**  
4x1.8 mm  
8x3.5 mm  
14x6 mm

**Crystal**

Crystal F (001)

**Colors**

**Plain Colors**

Aquamarine F (202)

Emerald F (205)

Graphite F (253)

Jet (280)

Sapphire F (206)

Scarlet F (276)

Vintage Rose F (319)

**Crystal Effects**

**Transparent Effects**

Crystal Aurore Boreale F (001 AB)

Crystal Golden Shadow F (001 GSHA)

**Color Effects**

**Transparent Effects**

Vintage Rose Shimmer F (319 SHIM)

**2300 Drop Flat Back**

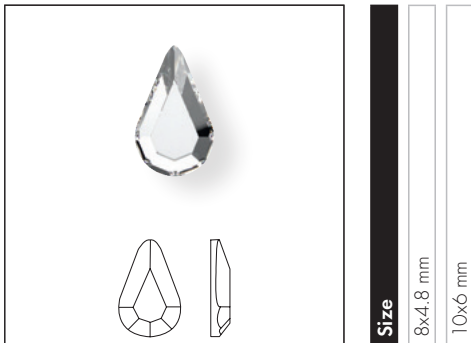

**Size**  
8x4.8 mm  
10x6 mm

**Crystal**

Crystal F (001)

**2205** Flame Flat Back

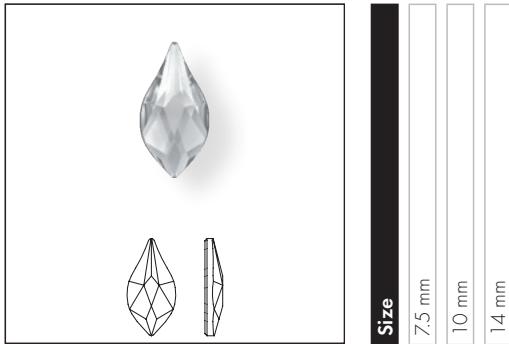

Crystal	7.5 mm	10 mm	14 mm
Crystal F (001)	■	■	■
<b>Colors</b>			
<b>Plain Colors</b>			
Light Siam F (227)	■	■	■
<b>Opal Colors</b>			
White Opal F (234)	■	■	■
<b>Crystal Effects</b>			
<b>Transparent Effects</b>			
Crystal Aurore Boreale F (001 AB)	■	■	■
Crystal Golden Shadow F (001 GSHA)	■	■	■

**2303** Pear Flat Back

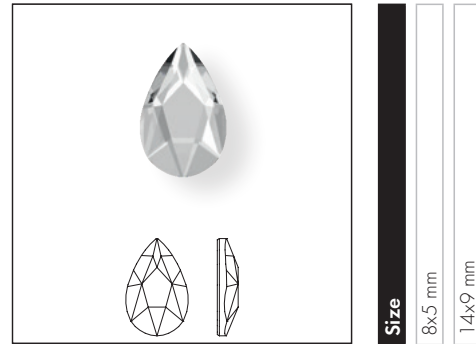

Crystal	8x5 mm	14x9 mm
Crystal F (001)	■	■
<b>Colors</b>		
<b>Plain Colors</b>		
Aquamarine F (202)	■	■
Emerald F (205)	■	■
Graphite F (253)	■	■
Jet (280)	■	■
Sapphire F (206)	■	■
Scarlet F (276)	■	■
Vintage Rose F (319)	■	■
<b>Crystal Effects</b>		
<b>Transparent Effects</b>		
Crystal Aurore Boreale F (001 AB)	■	■
Crystal Golden Shadow F (001 GSHA)	■	■
<b>Color Effects</b>		
<b>Transparent Effects</b>		
Vintage Rose Shimmer F (319 SHIM)	■	■

### 2304 Raindrop Flat Back

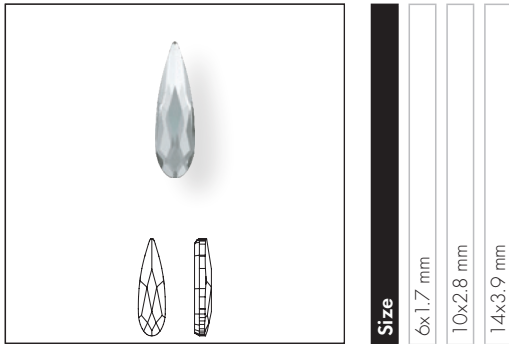

**Size**

6x1.7 mm  
10x2.8 mm  
14x3.9 mm

**Crystal**

Crystal F (001)

**Colors**

**Plain Colors**

Light Siam F (227)

**Crystal Effects**

**Transparent Effects**

Crystal Aurore Boreale F (001 AB)

Crystal Golden Shadow F (001 GSHA)

### 2400 Square Flat Back

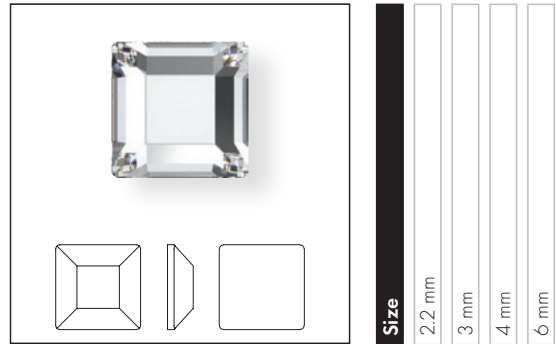

**Size**

2.2 mm  
3 mm  
4 mm  
6 mm

**Crystal**

Crystal F (001)

**Colors**

**Plain Colors**

Amethyst F (204)

Aquamarine F (202)

Black Diamond F (215)

Emerald F (205)

Jet (280)

Light Colorado Topaz F (246)

Light Rose F (223)

Scarlet F (276)

**Crystal Effects**

**Transparent Effects**

Crystal Aurore Boreale F (001 AB)

Crystal Golden Shadow F (001 GSHA)

Crystal Silver Night (001 SINI)

2471 Cushion Flat Back

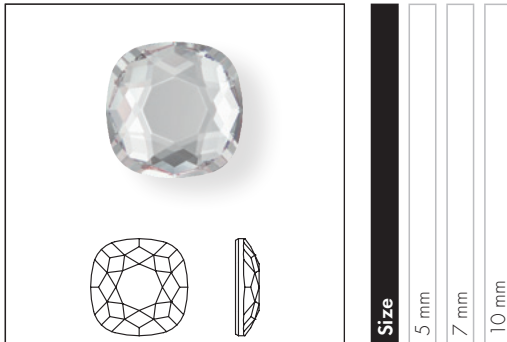

Crystal	5 mm	7 mm	10 mm
Crystal F (001)	■	■	■
Colors			
Plain Colors			
Aquamarine F (202)	■	■	■
Emerald F (205)	■	■	■
Graphite F (253)	■	■	■
Jet (280)	■	■	■
Sapphire F (206)	■	■	■
Scarlet F (276)	■	■	■
Vintage Rose F (319)	■	■	■
Crystal Effects			
Transparent Effects			
Crystal Aurore Boreale F (001 AB)	■	■	■
Crystal Golden Shadow F (001 GSHA)	■	■	■
Color Effects			
Transparent Effects			
Vintage Rose Shimmer F (319 SHIM)	■	■	■

2472

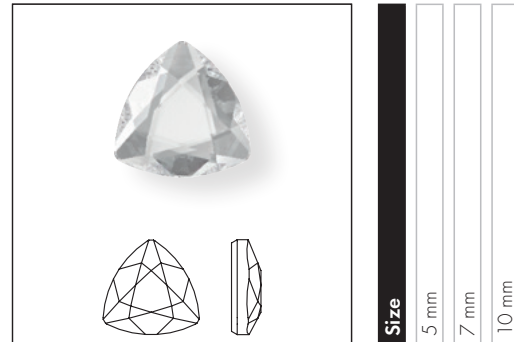

Crystal	5 mm	7 mm	10 mm
Crystal F (001)	■	■	■
Colors			
Plain Colors			
Aquamarine F (202)	■	■	■
Emerald F (205)	■	■	■
Graphite F (253)	■	■	■
Jet (280)	■	■	■
Sapphire F (206)	■	■	■
Scarlet F (276)	■	■	■
Vintage Rose F (319)	■	■	■
Crystal Effects			
Transparent Effects			
Crystal Aurore Boreale F (001 AB)	■	■	■
Crystal Golden Shadow F (001 GSHA)	■	■	■

**2483** Classic Square Flat Back

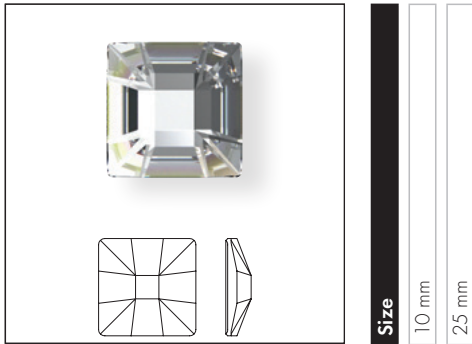

**Size**  
10 mm  
25 mm

**Crystal**

Crystal F (001)

**Crystal Effects**

**Metallic Effects**

Crystal Comet Argent Light SI (001 CASI)

Crystal Comet Argent Light V SI (001 CAVSI)

**2493** Chessboard Flat Back

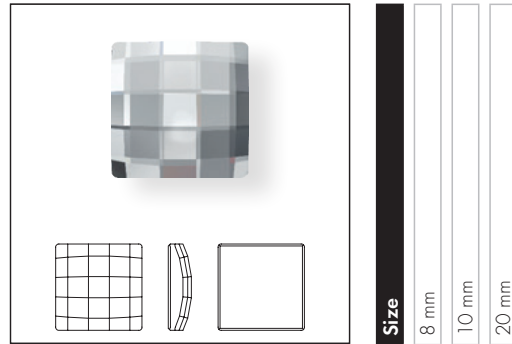

**Size**  
8 mm  
10 mm  
20 mm

**Crystal**

Crystal F (001)

**Crystal Effects**

**Transparent Effects**

Crystal Aurore Boreale F (001 AB)

**2510** Baguette Flat Back

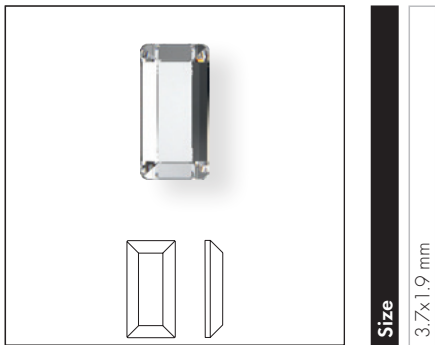

**Size**  
3.7x1.9 mm

**Crystal**

Crystal F (001)

**Colors**

**Plain Colors**

Jet (280)

**Crystal Effects**

**Transparent Effects**

Crystal Aurore Boreale F (001 AB)

Crystal Golden Shadow F (001 GSHA)

**2520** Cosmic Flat Back

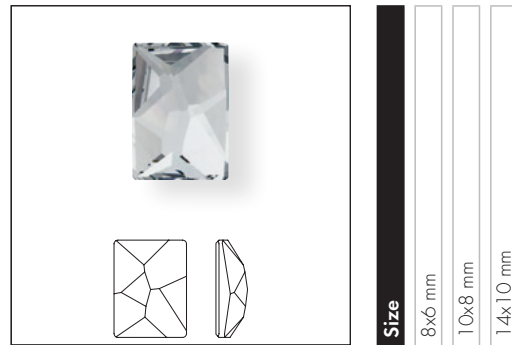

**Size**  
8x6 mm  
10x8 mm  
14x10 mm

**Crystal**

Crystal F (001)

**Colors**

**Plain Colors**

Jet (280)

**Crystal Effects**

**Transparent Effects**

Crystal Aurore Boreale F (001 AB)

Crystal Golden Shadow F (001 GSHA)

### 2555 Cosmic Baguette Flat Back

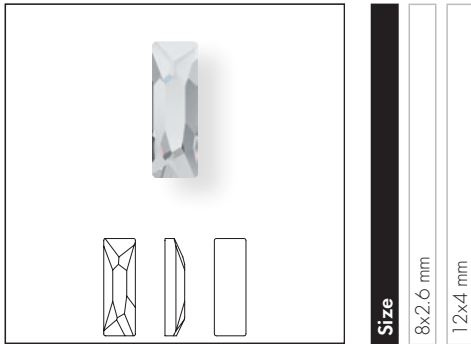

**Size**

8x2.6 mm

12x4 mm

**Crystal**

Crystal F (001)

**Crystal Effects**

**Transparent Effects**

Crystal Aurore Boreale F (001 AB)

Crystal Golden Shadow F (001 GSHA)

### 2602 Emerald Cut Flat Back

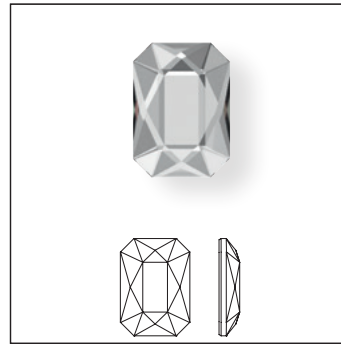

**Size**

3.7x2.5 mm

8x5.5 mm

14x10 mm

**Crystal**

Crystal F (001)

**Colors**

**Plain Colors**

Aquamarine F (202)

Emerald F (205)

Graphite F (253)

Jet (280)

Sapphire F (206)

Scarlet F (276)

Vintage Rose F (319)

**Crystal Effects**

**Transparent Effects**

Crystal Aurore Boreale F (001 AB)

Crystal Golden Shadow F (001 GSHA)

**Color Effects**

**Transparent Effects**

Vintage Rose Shimmer F (319 SHIM)



### 2603 Oval Flat Back

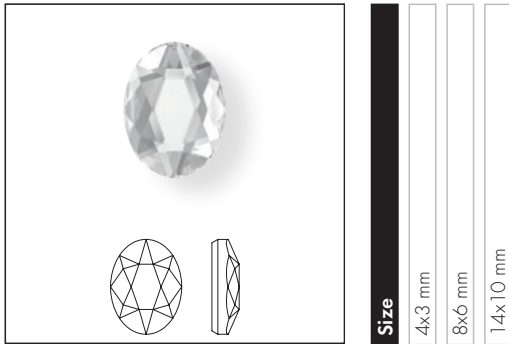

Crystal	4x3 mm	8x6 mm	14x10 mm
Crystal F (001)	■	■	■
Colors			
Plain Colors			
Aquamarine F (202)	■	■	■
Emerald F (205)	■	■	■
Graphite F (253)	■	■	■
Jet (280)	■	■	■
Sapphire F (206)	■	■	■
Scarlet F (276)	■	■	■
Vintage Rose F (319)	■	■	■
Crystal Effects			
Transparent Effects			
Crystal Aurore Boreale F (001 AB)	■	■	■
Crystal Golden Shadow F (001 GSHA)	■	■	■

### 2709 Rhombus Flat Back

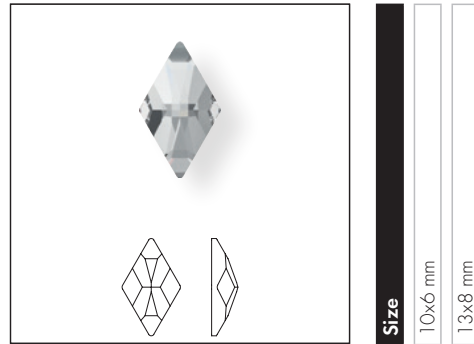

Crystal	10x6 mm	13x8 mm
Crystal F (001)	■	■
Colors		
Plain Colors		
Aquamarine F (202)	■	■
Black Diamond F (215)	■	■
Light Rose F (223)	■	■
Light Siam F (227)	■	■
Crystal Effects		
Transparent Effects		
Crystal Aurore Boreale F (001 AB)	■	■
Crystal Golden Shadow F (001 GSHA)	■	■
Crystal Silver Shade F (001 SSHA)	■	■

**2711 Triangle Flat Back**

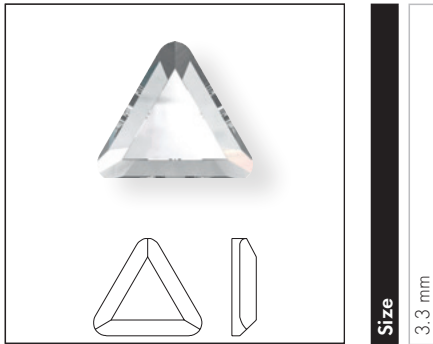

**Size**  
3.3 mm

**Crystal**

Crystal F (001)

**Crystal Effects**

**Transparent Effects**

Crystal Aurore Boreale F (001 AB)

Crystal Golden Shadow F (001 GSHA)

**2715 Connector Flat Back**

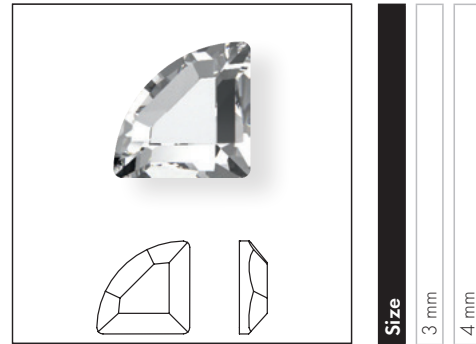

**Size**  
3 mm  
4 mm

**Crystal**

Crystal F (001)

**Colors**

**Plain Colors**

Amethyst F (204)

Aquamarine F (202)

Emerald F (205)

Jet (280)

Light Colorado Topaz F (246)

Scarlet F (276)

**Crystal Effects**

**Transparent Effects**

Crystal Aurore Boreale F (001 AB)

Crystal Golden Shadow F (001 GSHA)

Crystal Silver Night F (001 SINI)

**2716 Rivoli Triangle Flat Back**

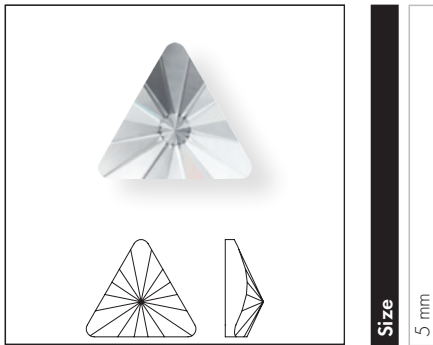

**Size**  
5 mm

**Crystal**

Crystal F (001)

**Crystal Effects**

**Transparent Effects**

Crystal Aurore Boreale F (001 AB)

**TRIANGLE FAMILY**

**2739** Triangle Beta Flat Back

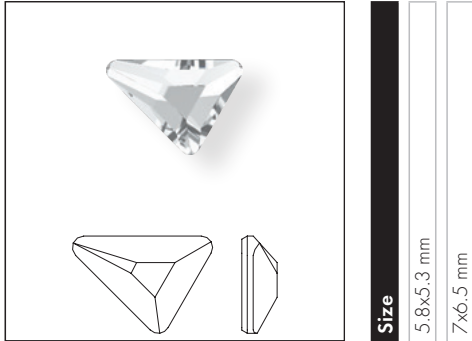

Crystal	
Crystal F (001)	
Crystal Effects	
Transparent Effects	
Crystal Aurore Boreale F (001 AB)	
Crystal Golden Shadow F (001 GSHA)	
Crystal Silver Night (001 SINI)	

**2740** Triangle Gamma Flat Back

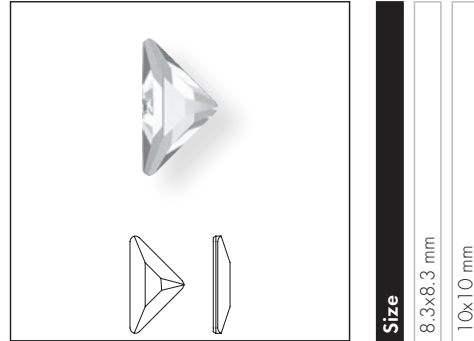

Crystal	
Crystal F (001)	
Crystal Effects	
Transparent Effects	
Crystal Aurore Boreale F (001 AB)	
Crystal Golden Shadow F (001 GSHA)	
Crystal Silver Night (001 SINI)	

**2754** Star Flower Flat Back NoHF

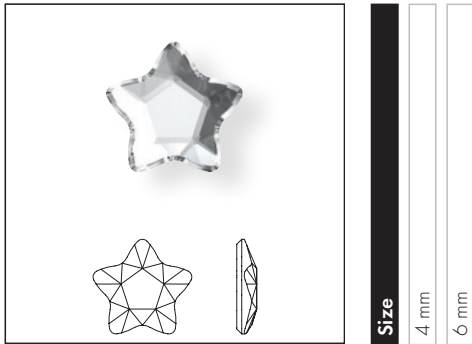

- Crystal**
- Crystal F (001)
- Colors**
- Plain Colors**
- Amethyst F (204)
- Aquamarine F (202)
- Iris F (219)
- Jet (280)
- Light Rose F (223)
- Light Topaz F (226)
- Peridot F (214)
- Rose F (209)
- Scarlet F (276)
- Crystal Effects**
- Transparent Effects**
- Crystal Aurore Boreale F (001 AB)
- Crystal Golden Shadow F (001 GSHA)

**2770** Wing Flat Back

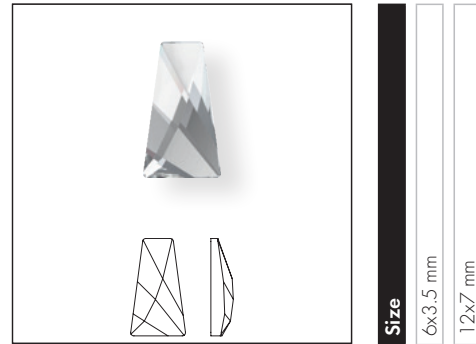

- Crystal**
- Crystal F (001)
- Colors**
- Plain Colors**
- Black Diamond F (215)
- Crystal Effects**
- Transparent Effects**
- Crystal Golden Shadow F (001 GSHA)

02

**GEOMETRIC FLAT BACKS**

**2771 Kite Flat Back**

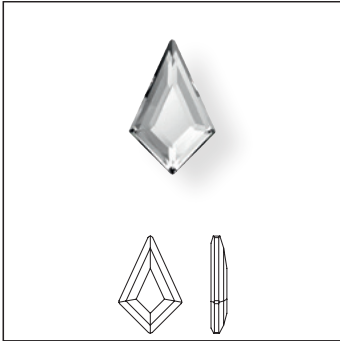

Size
6.4x4.2 mm
8.6x5.6 mm
12.9x8.3 mm

Crystal	Crystal F (001)		
Colors			
Plain Colors			
Aquamarine F (202)			
Black Diamond F (215)			
Jet (280)			
Light Rose F (223)			
Light Siam F (227)			
Crystal Effects			
Transparent Effects			
Crystal Aurore Boreale F (001 AB)			
Crystal Golden Shadow F (001 GSHA)			
Crystal Silver Shade F (001 SSHA)			
Color Effects			
Metallic Effects			
Jet Hematite (280 HEM)			

**2772 Trapeze Flat Back**

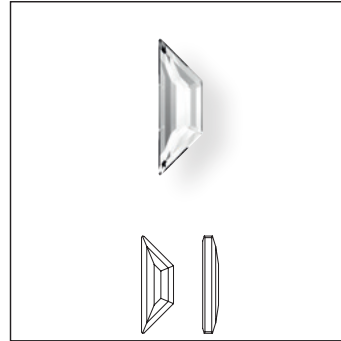

Size
6.5x2.1 mm
8.6x2.8 mm
12.9x4.2 mm

Crystal	Crystal F (001)		
Colors			
Plain Colors			
Aquamarine F (202)			
Black Diamond F (215)			
Jet (280)			
Crystal Effects			
Transparent Effects			
Crystal Aurore Boreale F (001 AB)			
Crystal Golden Shadow F (001 GSHA)			
Crystal Silver Shade F (001 SSHA)			
Color Effects			
Metallic Effects			
Jet Hematite (280 HEM)			

Geometric Flat Backs

**2773** Diamond Shape Flat Back

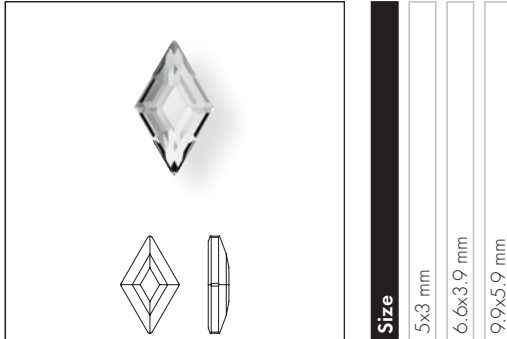

Crystal	5x3 mm	6.6x3.9 mm	9.9x5.9 mm
Crystal F (001)	■	■	■
Colors			
Plain Colors			
Aquamarine F (202)	■	■	■
Black Diamond F (215)	■	■	■
Jet (280)	■	■	■
Light Rose F (223)	■	■	■
Light Siam F (227)	■	■	■
Crystal Effects			
Transparent Effects			
Crystal Aurore Boreale F (001 AB)	■	■	■
Crystal Golden Shadow F (001 GSXA)	■	■	■
Crystal Silver Shade F (001 SSXA)	■	■	■
Color Effects			
Metallic Effects			
Jet Hematite (280 HEM)	■	■	■

**2774** Elongated Pentagon Flat Back

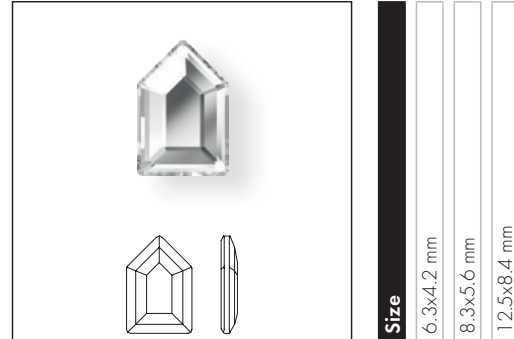

Crystal	6.3x4.2 mm	8.3x5.6 mm	12.5x8.4 mm
Crystal F (001)	■	■	■
Colors			
Plain Colors			
Aquamarine F (202)	■	■	■
Black Diamond F (215)	■	■	■
Jet (280)	■	■	■
Light Siam F (227)	■	■	■
Crystal Effects			
Transparent Effects			
Crystal Aurore Boreale F (001 AB)	■	■	■
Crystal Silver Shade F (001 SSXA)	■	■	■
Color Effects			
Metallic Effects			
Jet Hematite (280 HEM)	■	■	■

**2775** Concise Pentagon Flat Back



Size	5x4.2 mm	6.7x5.6 mm	10x8.4 mm
------	----------	------------	-----------

Crystal	Crystal F (001)		
Colors			
Plain Colors			
Aquamarine F (202)			
Black Diamond F (215)			
Jet (280)			
Light Siam F (227)			
Crystal Effects			
Transparent Effects			
Crystal Aurore Boreale F (001 AB)			
Crystal Silver Shade F (001 SSHA)			
Color Effects			
Metallic Effects			
Jet Hematite (280 HEM)			

**2776** Elongated Hexagon Flat Back

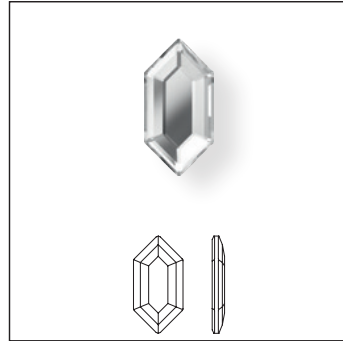

Size	8.2x4.2 mm	11x5.6 mm	16.5x8.4 mm
------	------------	-----------	-------------

Crystal	Crystal F (001)		
Colors			
Plain Colors			
Aquamarine F (202)			
Black Diamond F (215)			
Jet (280)			
Light Siam F (227)			
Crystal Effects			
Transparent Effects			
Crystal Aurore Boreale F (001 AB)			
Crystal Silver Shade F (001 SSHA)			
Color Effects			
Metallic Effects			
Jet Hematite (280 HEM)			

2777 Concise Hexagon Flat Back

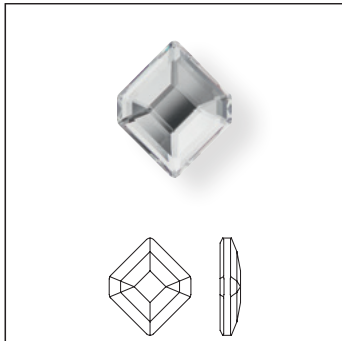

Size
5x4.2 mm
6.7x5.6 mm
10x8.4 mm

**Crystal**

Crystal F (001)

**Colors**

**Plain Colors**

Aquamarine F (202)

Black Diamond F (215)

Jet (280)

Light Siam F (227)

**Crystal Effects**

**Transparent Effects**

Crystal Aurore Boreale F (001 AB)

Crystal Silver Shade F (001 SSHA)

**Color Effects**

**Metallic Effects**

Jet Hematite (280 HEM)

Crystal F (001)	■	■	■
Aquamarine F (202)	■	■	
Black Diamond F (215)	■	■	■
Jet (280)	■	■	
Light Siam F (227)	■	■	■
Crystal Aurore Boreale F (001 AB)	■	■	■
Crystal Silver Shade F (001 SSHA)	■	■	
Jet Hematite (280 HEM)	■	■	■



**2808** Heart Flat Back

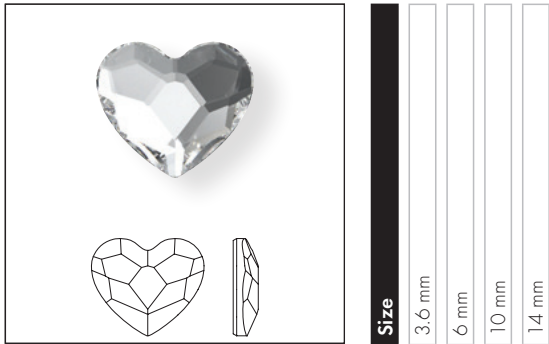

Crystal	3.6 mm	6 mm	10 mm	14 mm
Crystal F (001)	■	■	■	■
Colors				
Plain Colors				
Denim Blue F (266)		■	■	
Fuchsia F (502)		■	■	
Light Siam F (227)		■	■	
Crystal Effects				
Transparent Effects				
Crystal Aurore Boreale F (001 AB)	■	■	■	■
Crystal Golden Shadow F (001 GSHA)	■	■	■	■

**2813** Moon Flat Back



Crystal	8x5.5 mm
Crystal F (001)	■
Crystal Effects	
Transparent Effects	
Crystal Aurore Boreale F (001 AB)	■

**2816** Rivoli Star Flat Back

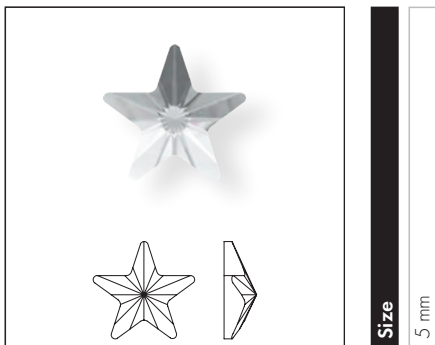

Crystal	5 mm
Crystal F (001)	■
Crystal Effects	
Transparent Effects	
Crystal Aurore Boreale F (001 AB)	■

### 2854 Butterfly Flat Back

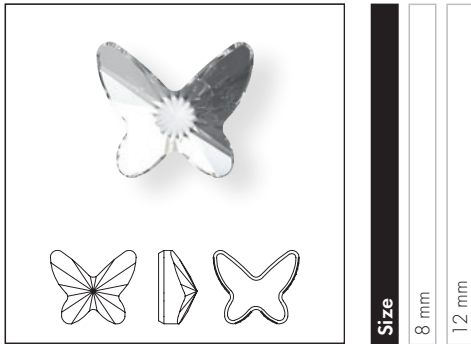

**Size**  
8 mm  
12 mm

Crystal	
Crystal F (001)	■ ■
Colors	
Plain Colors	
Amethyst F (204)	■ ■
Denim Blue F (266)	■ ■
Light Rose F (223)	■ ■
Crystal Effects	
Transparent Effects	
Crystal Aurore Boreale F (001 AB)	■ ■

### 2856 Skull Flat Back

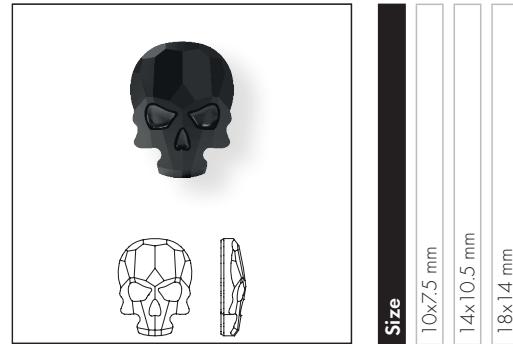

**Size**  
10x7.5 mm  
14x10.5 mm  
18x14 mm

Colors	
Plain Colors	
Jet (280)	■ ■ ■
Crystal Effects	
Transparent Effects	
Crystal Aurore Boreale F (001 AB)	■ ■ ■
Crystal Silver Night (001 SINI)	■ ■ ■
Color Effects	
Metallic Effects	
Jet Hematite (280 HEM)	■ ■ ■

# Product Details

Product Details

Article Size	Packing Unit = Minimum Order Quantity in Pieces	Average Net Weight in Gram per Packing Unit Crystal (001)	Average Gross Weight in Gram per Packing Unit Crystal (001)
<b>1098</b>			
PP 24 (SS 12)	1440	20.96	31.16
PP 31 (SS 16)	1440	41.13	51.33
SS 20	720	36.58	46.78
SS 24	720	56.14	66.34
SS 29	288	34.19	51.37
SS 34	144	28.66	45.84
SS 39	144	39.51	56.69
<b>2000</b>			
SS 3	1,440	1.8	12.7
SS 4	1,440	3.3	13.7
<b>2019</b>			
4 mm	144	10.8	32.1
5 mm	72	10.2	29.5
6 mm	72	17.4	35.0
<b>2035</b>			
6 mm	360	27.1	34.8
10 mm	192	56.2	88.0
14 mm	96	88.4	109.0
20 mm	40	82.0	121.4
30 mm	12	95.4	130.8
40 mm	6	105.3	140.3
<b>2058</b>			
SS 5	1,440	4.4	17.9
SS 6	1,440	5.7	17.6
SS 7	1,440	7.1	19.0
SS 8	1,440	10.1	19.6
SS 9	1,440	12.4	22.0
SS 10	1,440	15.8	25.3
<b>2072</b>			
8 mm	288	92.9	119.6
10 mm	144	90.6	111.0
12 mm	72	82.0	100.1
<b>2088</b>			
SS 12	1,440	22.1	30.3
SS 14	1,440	30.1	38.3
SS 16	1,440	39.9	49.8
SS 20	1,440	72.2	80.9
SS 24	1,440	127.12	136.3
SS 30	288	34.6	63.0
SS 34	144	25.9	48.6
SS 40	144	50.0	75.1
SS 48	96	76.1	101.3
<b>2200</b>			
4x2 mm	720	6.5	18.5
8x4 mm	720	49.6	60.2

Article Size	Packing Unit = Minimum Order Quantity in Pieces	Average Net Weight in Gram per Packing Unit Crystal (001)	Average Gross Weight in Gram per Packing Unit Crystal (001)
<b>2201</b>			
4x1.8 mm	720	5.7	15.9
8x3.5 mm	144	10.03	31.11
14x6 mm	72	21.67	45.27
<b>2205</b>			
7.5 mm	288	20.3	30.5
10 mm	144	17.6	42.4
14 mm	72	22.3	45.9
<b>2300</b>			
8x4.8 mm	720	83.9	94.5
10x6 mm	360	56.9	67.8
<b>2303</b>			
8x5 mm	144	15.70	39.60
14x9 mm	72	36.65	60.25
<b>2304</b>			
10x2.8 mm	180	10.3	20.5
14x3.9 mm	96	13.1	36.3
6x1.7 mm	360	7.5	16.2
<b>2400</b>			
2.2 mm	1,440	11.3	21.7
3 mm	1,440	25.3	36.8
4 mm	720	30.0	41.0
6 mm	144	21.6	32.5
<b>2471</b>			
5 mm	288	17.3	25.6
7 mm	72	11.9	35.1
10 mm	72	30.2	51.6
<b>2472</b>			
5 mm	288	17.4	27.6
7 mm	144	20.8	42.8
10 mm	96	34.5	56.5
<b>2483</b>			
10 mm	144	90.3	120.2
25 mm	32	233.3	261.5
<b>2493</b>			
8 mm	216	72.3	91.8
10 mm	144	84.4	106.1
20 mm	24	108.5	137.9
<b>2510</b>			
3.7x1.9 mm	720	8.2	10.6
<b>2520</b>			
8x6 mm	288	50.8	80.2
10x8 mm	144	72.3	90.4
14x10 mm	144	119.3	140.8

Article Size	Packing Unit = Minimum Order Quantity in Pieces	Average Net Weight in Gram per Packing Unit Crystal (001)	Average Gross Weight in Gram per Packing Unit Crystal (001)
<b>2555</b>			
8x2.6 mm	240	18.4	27.5
12x4 mm	144	28.8	33.6
<b>2602</b>			
3.7x2.5 mm	720	11.5	21.7
8x5.5 mm	144	17.89	41.79
14x10 mm	72	58.61	82.21
<b>2603</b>			
4x3 mm	288	6.8	17.0
8x6 mm	144	21.7	43.7
14x10 mm	72	50.3	72.3
<b>2709</b>			
10x6 mm	288	48.2	73.6
13x8 mm	144	41.0	60.1
<b>2711</b>			
3.3 mm	720	10.2	16.4
<b>2715</b>			
3 mm	288	4.0	14.2
4 mm	288	8.2	18.4
<b>2716</b>			
5 mm	720	35.8	75.1
<b>2739</b>			
5.8x5.3 mm	216	19.2	41.9
7x6.5 mm	144	22.6	39.8
<b>2740</b>			
8.3x8.3 mm	216	35.1	54.2
10x10 mm	96	25.1	41.1
<b>2754</b>			
4 mm	720	13.6	23.8
6 mm	360	20.5	30.7
<b>2770</b>			
6x3.5 mm	1,440	60.3	70.3
12x7 mm	192	49.8	98.4
<b>2771</b>			
6.4x4.2 mm	288	9.04	17.87
8.6x5.6 mm	216	16.84	43.02
12.9x8.3 mm	144	36.29	61.39
<b>2772</b>			
6.5x2.1 mm	288	6.39	15.17
8.6x2.8 mm	288	16.29	40.71
12.9x4.2 mm	144	25.57	53.86
<b>2773</b>			
5x3 mm	288	4.83	13.66
6.6x3.9 mm	288	11.23	35.65
9.9x5.9 mm	144	19.30	43.39

Article Size	Packing Unit = Minimum Order Quantity in Pieces	Average Net Weight in Gram per Packing Unit Crystal (001)	Average Gross Weight in Gram per Packing Unit Crystal (001)
<b>2774</b>			
6.3x4.2 mm	288	18.7	29.6
8.3x5.6 mm	144	19.5	39.4
12.5x8.4 mm	96	39.0	60.3
<b>2775</b>			
5x4.2 mm	288	13.9	24.7
6.7x5.6 mm	144	15.0	34.3
10x8.4 mm	144	43.6	66.4
<b>2776</b>			
8.2x4.2 mm	144	11.2	30.1
11x5.6 mm	72	11.3	28.8
16.5x8.4 mm	72	35.6	55.8
<b>2777</b>			
5x4.2 mm	288	10.4	21.3
6.7x5.6 mm	144	10.5	29.7
10x8.4 mm	144	32.8	52.7
<b>2808</b>			
3.6 mm	720	18.4	20.8
6 mm	288	19.8	28.9
10 mm	144	38.8	55.9
14 mm	96	56.4	86.8
<b>2813</b>			
8x5.5 mm	144	13.1	37.7
<b>2816</b>			
5 mm	720	23.6	30.7
<b>2854</b>			
8 mm	216	36.0	52.2
12 mm	144	84.4	103.8
<b>2856</b>			
10x7.5 mm	72	20.2	38.6
14x10.5 mm	36	30.2	50.3
18x14 mm	30	53.0	83.4