

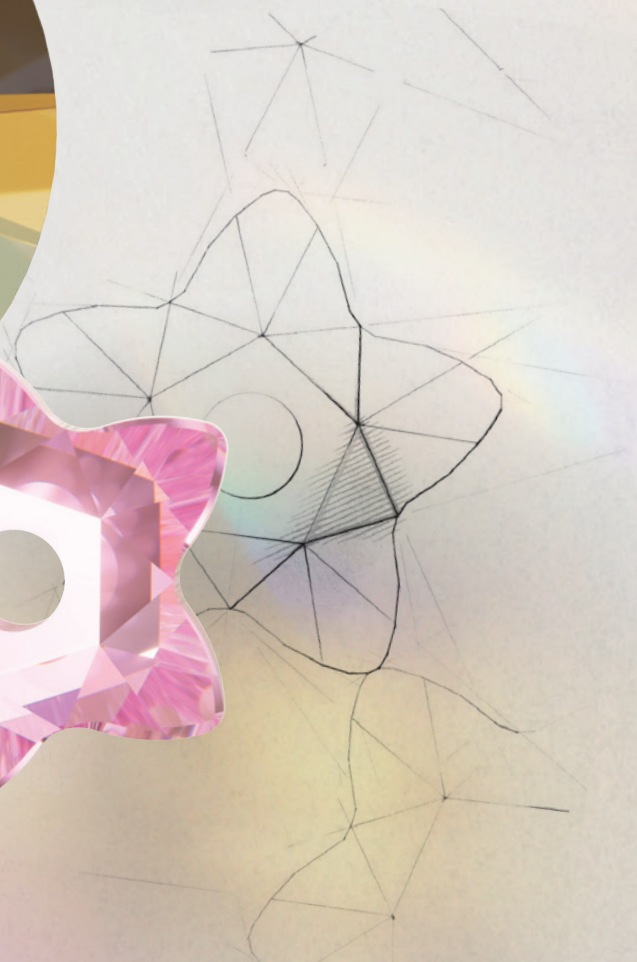

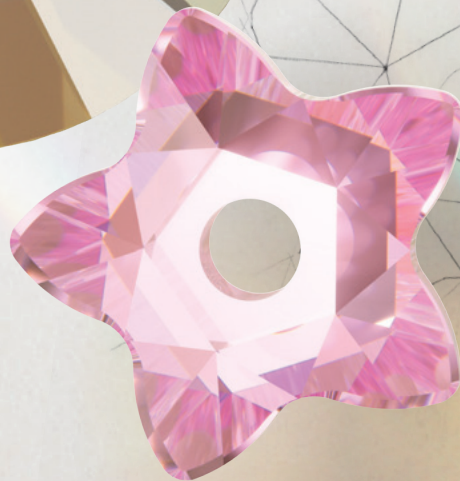













# Sew-on Articles & Crystal Buttons

Sew-On Articles are loose crystals with holes offering convenient sewing options, either sewn by hand, or applied with a standard or industrial embroidery sewing machine. Effortlessly attached to various textiles, they craft beautiful creative embellishment possibilities.









The standout products within this product group are the art. 3188 XIRIUS Lochrose and art. 3288 XIRIUS Sew-on Stones. Completely unique, these items boast innovative multi-layer cutting technology to create the inspiring XIRIUS star design, setting them apart as the most progressive and distinctive designs available in the market.



## Colors

- |   |   |
|---|---|
|  Crystal<br>001    |  Denim Blue<br>266           |
|  Light Silk<br>261 |  Peridot<br>214              |
|  Blush Rose<br>257 |  Fern Green<br>291           |
|  Light Rose<br>223 |  Emerald<br>205              |
|  Light Siam<br>227 |  Light Topaz<br>226          |
|  Scarlet<br>276    |  Light Colorado Topaz<br>246 |
|  Amethyst<br>204   |  Black Diamond<br>215        |
|  Aquamarine<br>202 |  Jet<br>280                  |

## Effects

- |  |
|--|
|  Crystal Moonlight<br>001 MOL           |
|  Crystal Shimmer<br>001 SHIM            |
|  Crystal Aurore Boreale<br>001 AB       |
|  Crystal Vitrail Medium<br>001 VM       |
|  Crystal Golden Shadow<br>001 GSHA      |
|  Crystal Metallic Sunshine<br>001 METSH |
|  Crystal Silver Shade<br>001 SSHA       |
|  Crystal Silver Night<br>001 SINI       |
|  Jet Hematite<br>280 HEM                |

## Numerical Order

001	Crystal
001 AB	Crystal Aurore Boreale
001 GSHA	Crystal Golden Shadow
001 METSH	Crystal Metallic Sunshine
001 MOL	Crystal Moonlight
001 SHIM	Crystal Shimmer
001 SINI	Crystal Silver Night
001 SSHA	Crystal Silver Shade
001 VM	Crystal Vitrail Medium
202	Aquamarine
204	Amethyst
205	Emerald
214	Peridot
215	Black Diamond
223	Light Rose
226	Light Topaz
227	Light Siam
246	Light Colorado Topaz
257	Blush Rose
261	Light Silk
266	Denim Blue
276	Scarlet
280 HEM	Jet Hematite
280	Jet
291	Fern Green

## Alphabetical Order

Amethyst (204)
Aquamarine (202)
Black Diamond (215)
Blush Rose (257)
Crystal (001)
Crystal Aurore Boreale (001 AB)
Crystal Golden Shadow (001 GSHA)
Crystal Metallic Sunshine (001 METSH)
Crystal Moonlight (001 MOL)
Crystal Shimmer (001 SHIM)
Crystal Silver Night (001 SINI)
Crystal Silver Shade (001 SSHA)
Crystal Vitrail Medium (001 VM)
Denim Blue (266)
Emerald (205)
Fern Green (291)
Jet (280)
Jet Hematite (280 HEM)
Light Colorado Topaz (246)
Light Rose (223)
Light Siam (227)
Light Silk (261)
Light Topaz (226)
Peridot (214)
Scarlet (276)

For details on available colors and effects for each article within the product groups, please see the product matrix of the respective item in the Collection 2023.



The plating resistance of effects is tested according to Swarovski's plating guidelines (SWAROVSKI.COM/S-PROFESSIONALS). Customers are advised to carry out their own tests if their plating parameters diverge from Swarovski plating guidelines.

Colors and effects can appear different when illuminated with different light sources. Swarovski uses standard light source D65 for color decision and comparison. Slight changes in shades are unavoidable. Colors may vary according to cut and foiling.

The composition of Advanced Crystal is compliant with regulatory industry norms and laws regarding the restriction or prohibition of certain substances in the most relevant segments of our customers. Please note that the compliance of the colors Light Siam and Siam varies according to certain industry regulations. Those regulations are indicated with \* in the compliance overview. Indian Siam, Ruby and Scarlet (option to Lt. Siam) conform to all CLEAR-lists. For further information please visit [swarovski.com/s-professionals](http://swarovski.com/s-professionals)

© 2023 D. Swarovski Distribution GmbH

# Summary

- |   |   |   |   |   |                                    |
|---|---|---|---|---|------------------------------------|
| 1   | 2   |   | 1   | 2   |                                    |
|    |    | <b>3188</b><br>3, 4, 5, 6, 7, 8 mm                          |  |  | <b>3288</b><br>8, 10, 12 mm        |
|    |    | <b>3200</b><br>8, 10, 12, 14, 16, 18 mm                     |  |  | <b>3700</b><br>6, 8, 10, 12, 14 mm |
|    |    | <b>3210</b><br>10x7, 16x11, 24x17 mm                        |  |  | <b>3754</b><br>5, 7 mm             |
|    |    | <b>3223</b><br>12x6, 18x9,<br>29x14.5 mm                    |   |   |                                    |
|   |   | <b>3230</b><br>12x7, 18x10.5, 23x13.8,<br>28x17, 34x20.4 mm |   |   |                                    |
|  |  | <b>3240</b><br>16, 22 mm                                    |   |   |                                    |
|  |  | <b>3252</b><br>14x10, 20x14,<br>28x20 mm                    |   |   |                                    |
|  |  | <b>3255</b><br>18x6, 26x8.5 mm                              |   |   |                                    |
|  |  | <b>3256</b><br>14x8.5, 19x11.5,<br>27x16 mm                 |   |   |                                    |
|  |  | <b>3265</b><br>20x16, 26x21 mm                              |   |   |                                    |
|  |  | <b>3270</b><br>16, 22 mm                                    |   |   |                                    |

1 Top view 2 Side view

3188 XIRIUS Lochrose

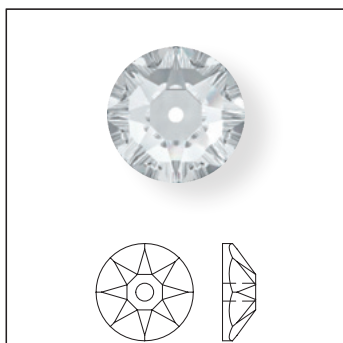

Size	3 mm	4 mm	5 mm	6 mm	7 mm	8 mm
------	------	------	------	------	------	------

**Crystal**

- Crystal (001)
- Crystal F (001)

**Colors**

**Plain Colors**

- Aquamarine F (202)
- Black Diamond F (215)
- Blush Rose F (257)
- Denim Blue F (266)
- Emerald F (205)
- Jet (280)
- Light Colorado Topaz F (246)
- Light Rose F (223)
- Light Siam F (227)
- Light Silk F (261)
- Scarlet F (276)

**Crystal Effects**

**Transparent Effects**

- Crystal Aurore Boreale F (001 AB)
- Crystal Golden Shadow F (001 GSHA)
- Crystal Moonlight F (001 MOL)
- Crystal Silver Night (001 SINI)
- Crystal Silver Shade F (001 SSHA)

**Metallic Effects**

- Crystal Metallic Sunshine F (001 METSH)

**Color Effects**

**Metallic Effects**

- Jet Hematiite (280 HEM)

Crystal (001)	■	■	■			
Crystal F (001)	■	■	■	■	■	■
Aquamarine F (202)	■	■	■			
Black Diamond F (215)	■	■	■			
Blush Rose F (257)	■	■	■			
Denim Blue F (266)	■	■	■			
Emerald F (205)	■	■	■			
Jet (280)	■	■	■	■	■	■
Light Colorado Topaz F (246)	■	■	■			
Light Rose F (223)	■	■	■			
Light Siam F (227)	■	■	■			
Light Silk F (261)	■	■	■			
Scarlet F (276)	■	■	■			
Crystal Aurore Boreale F (001 AB)	■	■	■	■	■	■
Crystal Golden Shadow F (001 GSHA)	■	■	■	■	■	■
Crystal Moonlight F (001 MOL)	■	■	■			
Crystal Silver Night (001 SINI)		■	■			
Crystal Silver Shade F (001 SSHA)	■	■	■			
Crystal Metallic Sunshine F (001 METSH)	■	■	■			
Jet Hematiite (280 HEM)	■	■	■			

### 3200 Rivoli Sew-on Stone

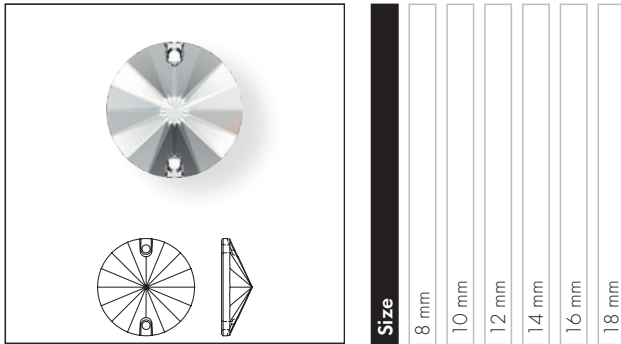

	8 mm	10 mm	12 mm	14 mm	16 mm	18 mm
<b>Crystal</b>						
Crystal F (001)	■	■	■	■	■	■
<b>Colors</b>						
<b>Plain Colors</b>						
Aquamarine F (202)	■	■	■	■		
Black Diamond F (215)	■	■	■	■		
Emerald F (205)	■	■	■	■		
Jet (280)	■	■	■	■		
Light Colorado Topaz F (246)	■	■	■	■		
Light Rose F (223)	■	■	■	■		
Light Siam F (227)	■	■	■	■		
Scarlet F (276)	■	■	■	■		
<b>Crystal Effects</b>						
<b>Transparent Effects</b>						
Crystal Aurore Boreale F (001 AB)	■	■	■	■	■	■
Crystal Golden Shadow F (001 GSHA)	■	■	■	■		
<b>Metallic Effects</b>						
Crystal Metallic Sunshine F (001 METSH)	■	■	■	■		
<b>Color Effects</b>						
<b>Metallic Effects</b>						
Jet Hematite (280 HEM)	■	■	■	■		

### 3210 Oval Sew-on Stone

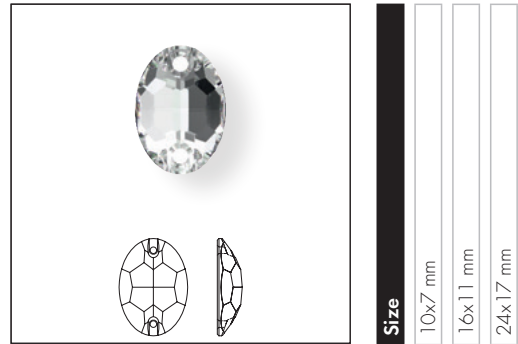

	10x7 mm	16x11 mm	24x17 mm
<b>Crystal</b>			
Crystal F (001)	■	■	■
<b>Colors</b>			
<b>Plain Colors</b>			
Jet (280)	■	■	■
<b>Crystal Effects</b>			
<b>Transparent Effects</b>			
Crystal Aurore Boreale F (001 AB)	■	■	■

**3223** Navette Sew-on Stone



**Size**

12x6 mm  
18x9 mm  
29x14.5 mm

**Crystal**

Crystal F (001)

**Colors**

**Plain Colors**

Aquamarine F (202)

Black Diamond F (215)

Emerald F (205)

Jet (280)

Light Colorado Topaz F (246)

**Crystal Effects**

**Transparent Effects**

Crystal Aurore Boreale F (001 AB)

Crystal Golden Shadow F (001 GSHA)

**3230** Drop Sew-on (Size Extension)



**Size**

12x7 mm  
18x10.5 mm  
23x13.8 mm  
28x17 mm  
34x20.4 mm

**Crystal**

Crystal F (001)

**Colors**

**Plain Colors**

Aquamarine F (202)

Black Diamond F (215)

Emerald F (205)

Jet (280)

Light Colorado Topaz F (246)

Light Rose F (223)

Scarlet F (276)

**Crystal Effects**

**Transparent Effects**

Crystal Aurore Boreale F (001 AB)

Crystal Golden Shadow F (001 GSHA)

Crystal Silver Night (001 SINI)



**3240** Square Sew-on Stone

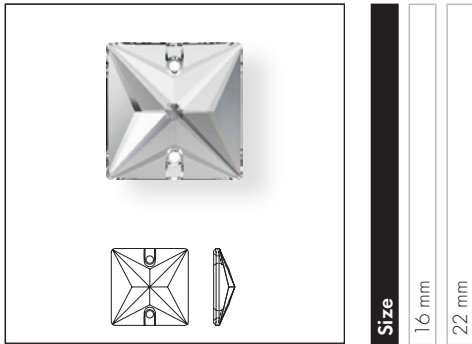

**Size**  
16 mm  
22 mm

**Crystal**

Crystal F (001)

**Colors**

**Plain Colors**

Jet (280)

**Crystal Effects**

**Transparent Effects**

Crystal Aurore Boreale F (001 AB)

**3252** Emerald Cut Sew-on Stone

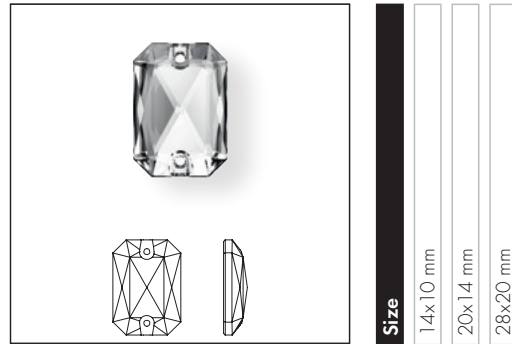

**Size**  
14x10 mm  
20x14 mm  
28x20 mm

**Crystal**

Crystal F (001)

**Colors**

**Plain Colors**

Jet (280)

**Crystal Effects**

**Transparent Effects**

Crystal Aurore Boreale F (001 AB)

**3255** Cosmic Baguette Sew-on Stone

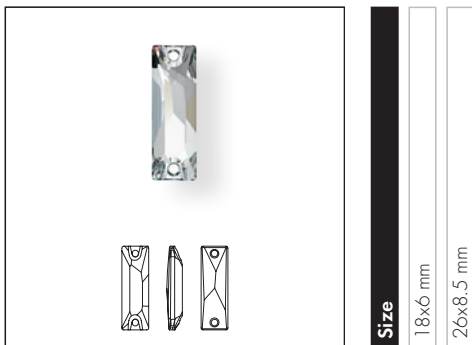

**Size**  
18x6 mm  
26x8.5 mm

**Crystal**

Crystal F (001)

**Colors**

**Plain Colors**

Jet (280)

**Crystal Effects**

**Transparent Effects**

Crystal Aurore Boreale F (001 AB)

**3256** Galactic Sew-on Stone

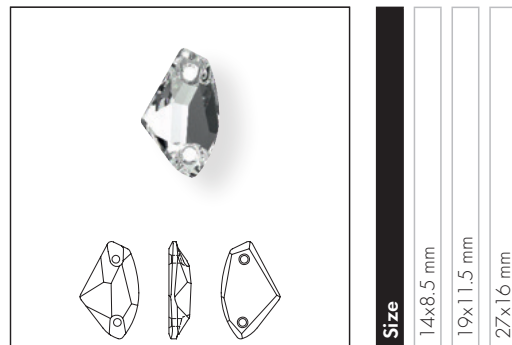

**Size**  
14x8.5 mm  
19x11.5 mm  
27x16 mm

**Crystal**

Crystal F (001)

**Colors**

**Plain Colors**

Jet (280)

**Crystal Effects**

**Transparent Effects**

Crystal Aurore Boreale F (001 AB)

**3265** Cosmic Sew-on Stone



**Size**

20x16 mm

26x21 mm

**Crystal**

Crystal F (001)

**Colors**

**Plain Colors**

Jet (280)

**Crystal Effects**

**Transparent Effects**

Crystal Aurore Boreale F (001 AB)

**3270** Triangle Sew-on Stone

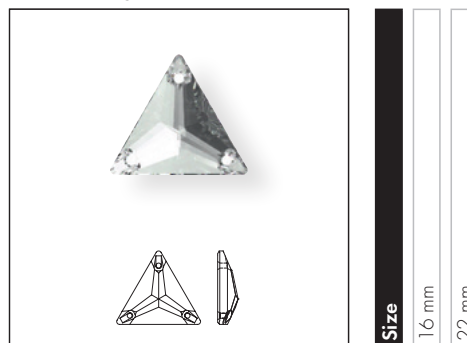

**Size**

16 mm

22 mm

**Crystal**

Crystal F (001)

**Colors**

**Plain Colors**

Jet (280)

**Crystal Effects**

**Transparent Effects**

Crystal Aurore Boreale F (001 AB)

### 3288 XIRIUS Sew-on Stone

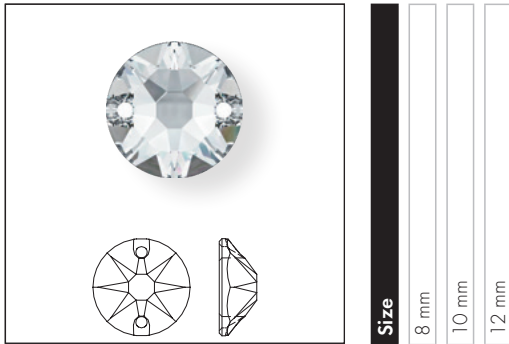

**Size**  
8 mm  
10 mm  
12 mm

Crystal			
Crystal F (001)	8 mm	10 mm	12 mm
Colors			
Plain Colors			
Aquamarine F (202)	8 mm	10 mm	12 mm
Black Diamond F (215)	8 mm	10 mm	12 mm
Blush Rose F (257)	8 mm	10 mm	12 mm
Denim Blue F (266)	8 mm	10 mm	12 mm
Emerald F (205)	8 mm	10 mm	12 mm
Jet (280)	8 mm	10 mm	12 mm
Light Colorado Topaz F (246)	8 mm	10 mm	12 mm
Light Rose F (223)	8 mm	10 mm	12 mm
Light Siam F (227)	8 mm	10 mm	12 mm
Scarlet F (276)	8 mm	10 mm	12 mm
Crystal Effects			
Transparent Effects			
Crystal Aurore Boreale F (001 AB)	8 mm	10 mm	12 mm
Crystal Golden Shadow F (001 GSHA)	8 mm	10 mm	12 mm
Crystal Moonlight F (001 MOL)	8 mm	10 mm	12 mm
Crystal Silver Night (001 SINI)	8 mm	10 mm	12 mm
Crystal Silver Shade F (001 SSHA)	8 mm	10 mm	12 mm
Metallic Effects			
Crystal Metallic Sunshine F (001 METSH)	8 mm	10 mm	12 mm
Color Effects			
Metallic Effects			
Jet Hematite (280 HEM)	8 mm	10 mm	12 mm

### 3700 Marguerite Lochrose

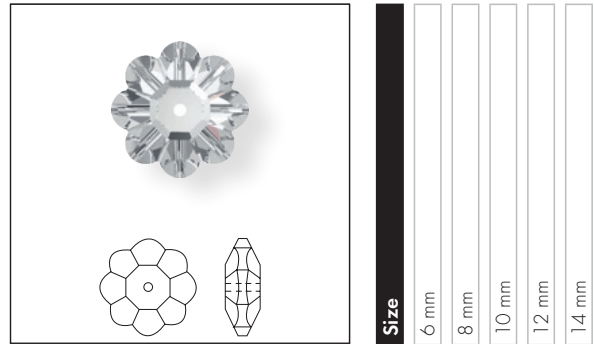

**Size**  
6 mm  
8 mm  
10 mm  
12 mm  
14 mm

Crystal					
Crystal (001)	6 mm	8 mm	10 mm	12 mm	14 mm
Crystal F (001)	6 mm	8 mm	10 mm	12 mm	14 mm
Colors					
Plain Colors					
Fern Green (291)	6 mm	8 mm	10 mm	12 mm	14 mm
Jet (280)	6 mm	8 mm	10 mm	12 mm	14 mm
Light Siam (227)	6 mm	8 mm	10 mm	12 mm	14 mm
Peridot (214)	6 mm	8 mm	10 mm	12 mm	14 mm
Crystal Effects					
Transparent Effects					
Crystal Aurore Boreale (001 AB)	6 mm	8 mm	10 mm	12 mm	14 mm
Crystal Golden Shadow (001 GSHA)	6 mm	8 mm	10 mm	12 mm	14 mm
Crystal Shimmer (001 SHIM)	6 mm	8 mm	10 mm	12 mm	14 mm
Crystal Vitrail Medium (001 VM)	6 mm	8 mm	10 mm	12 mm	14 mm

**3754** Star Flower Sew-on Stone



Size	5 mm	7 mm
------	------	------

**Crystal**

Crystal F (001)

**Colors**

**Plain Colors**

Amethyst F (204)

Aquamarine F (202)

Emerald F (205)

Iris F (219)

Jet (280)

Light Rose F (223)

Light Topaz F (226)

Scarlet F (276)

**Crystal Effects**

**Transparent Effects**

Crystal Aurore Boreale F (001 AB)

Crystal Golden Shadow F (001 GSHA)

# Product Details

Article Size	Packing Unit = Minimum Order Quantity in Pieces	Average Net Weight in Gram per Packing Unit Crystal (001)	Average Gross Weight in Gram per Packing Unit Crystal (001)
<b>3188</b>			
3 mm	1,440	21.5	30.0
4 mm	1,440	47.6	56.0
5 mm	720	43.2	51.7
6 mm	360	35.7	44.1
7 mm	144	22.2	30.7
8 mm	144	33.2	41.7
<b>3200</b>			
8 mm	144	34.0	53.0
10 mm	72	26.1	44.6
12 mm	72	54.9	74.0
14 mm	72	77.2	100.7
16 mm	72	115.8	139.4
18 mm	48	117.2	199.5
<b>3210</b>			
10x7 mm	72	18.1	37.9
16x11 mm	72	66.3	86.3
24x17 mm	24	72.5	97.9
<b>3223</b>			
12x6 mm	48	13.1	34.2
18x9 mm	36	27.7	45.1
29x14.5 mm	24	74.28	101.3
<b>3230</b>			
12x7 mm	96	29.7	47.0
18x10.5 mm	72	70.5	90.7
23x13.8 mm	36	67	95
28x17 mm	24	72.1	97.5
34x20.4 mm	16	96	122
<b>3240</b>			
16 mm	72	108.5	132.1
22 mm	24	88.0	139.6
<b>3252</b>			
14x10 mm	36	29.59	50.19
20x14 mm	15	35.55	60.28
28x20 mm	10	67.65	88.78
<b>3255</b>			
18x6 mm	96	64.3	87.1
26x8.5 mm	48	87.6	125.6
<b>3256</b>			
14x8.5 mm	96	48.2	67.5
19x11.5 mm	96	104.5	140.1
27x16 mm	30	95.4	128.9
<b>3265</b>			
20x16 mm	72	113.5	138.4
26x21 mm	20	59.8	85.0
<b>3270</b>			
16 mm	72	96.4	120.0
22 mm	24	72.3	117.4

Article Size	Packing Unit = Minimum Order Quantity in Pieces	Average Net Weight in Gram per Packing Unit Crystal (001)	Average Gross Weight in Gram per Packing Unit Crystal (001)
<b>3288</b>			
8 mm	144	51.0	61.9
10 mm	72	53.9	80.3
12 mm	72	69.8	96.5
<b>3700</b>			
6 mm	720	50.6	61.4
8 mm	288	62.2	88.4
10 mm	288	114.5	141.0
12 mm	144	105.4	128.5
14 mm	144	170.5	197.2
<b>3754</b>			
5 mm	720	28.4	38.6
7 mm	144	14.6	24.8



# Crystal Buttons



# Summary

1 2 3



**3008**  
12, 14, 18 mm



**3015**  
10, 12, 14, 16,  
18, 23, 27 mm



**3019**  
12, 14, 16 mm

3008 Classic Crystal Button (4 holes)

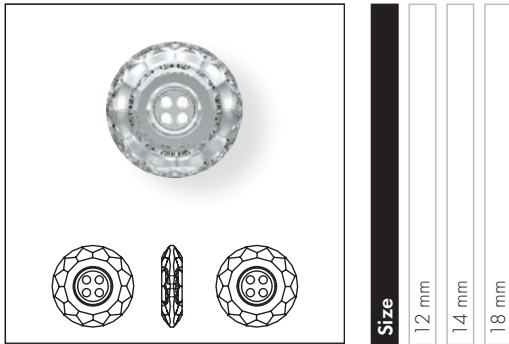

Crystal	12 mm	14 mm	18 mm
Crystal F (001)	■	■	■
Colors			
Plain Colors			
Jet (280)	■	■	■

3015 Classic Rivoli Crystal Button

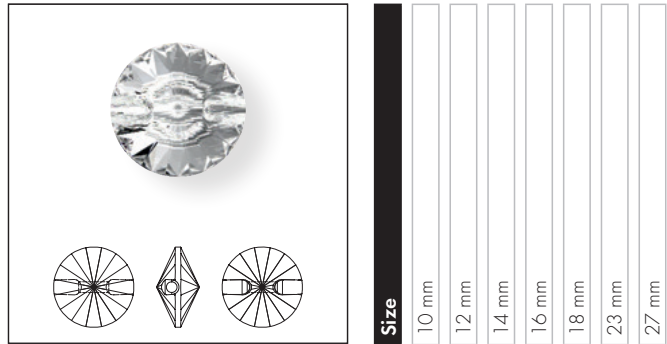

Crystal	10 mm	12 mm	14 mm	16 mm	18 mm	23 mm	27 mm
Crystal F (001)	■	■	■	■	■	■	■
Colors							
Plain Colors							
Black Diamond F (215)	■	■					
Jet (280)	■	■	■	■	■	■	■
Crystal Effects							
Transparent Effects							
Crystal Aurore Boreale F (001 AB)	■	■					
Crystal Golden Shadow F (001 GSHA)	■	■					

3019 Rivoli Crystal Button (2 holes)

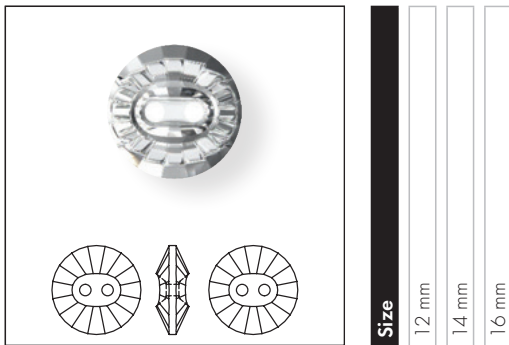

Crystal	12 mm	14 mm	16 mm
Crystal F (001)	■	■	■
Colors			
Plain Colors			
Jet (280)	■	■	■

# Product Details

Article Size	Packing Unit = Minimum Order Quantity in Pieces	Average Net Weight in Gram per Packing Unit Crystal (001)	Average Gross Weight in Gram per Packing Unit Crystal (001)
<b>3008</b>			
12 mm	48	29.9	50.8
14 mm	36	32.0	50.5
18 mm	24	52.3	72.0
<b>3015</b>			
10 mm	72	35.4	54.0
12 mm	48	41.4	59.9
14 mm	36	42.5	59.8
16 mm	24	47.6	64.9
18 mm	24	62.1	79.1
23 mm	8	42.9	64.9
27 mm	8	67.6	89.6
<b>3019</b>			
12 mm	48	31.2	51.3
14 mm	36	41.4	59.3
16 mm	24	39.8	62.5

